

## Measure the volume of beakers

Check (✓) the beakers with a volume of 4 liters

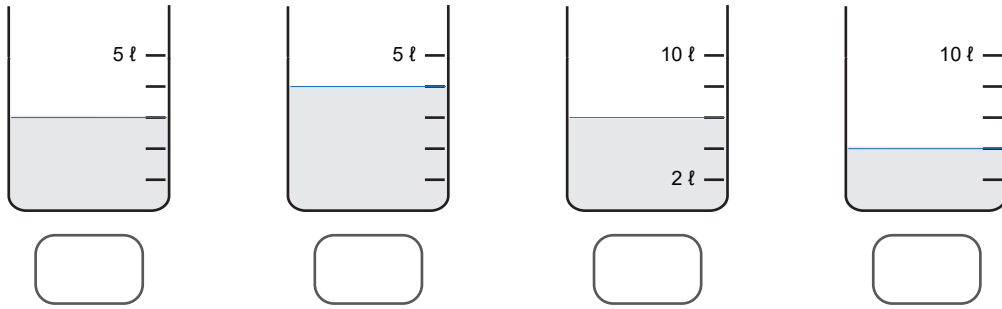

Check (✓) the beakers with a volume of 6 liters

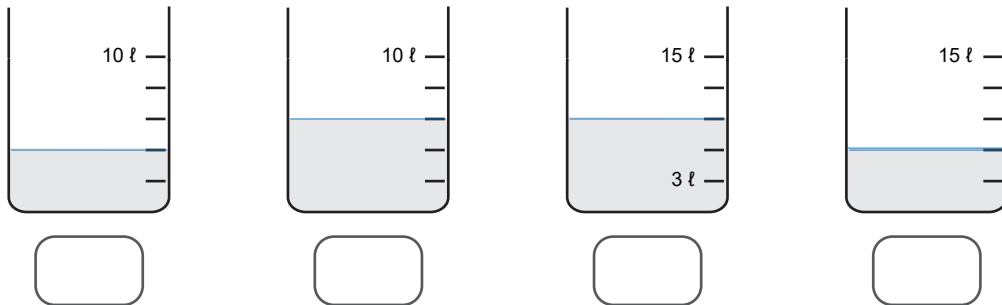

Check (✓) the beakers with a volume of 5 liters

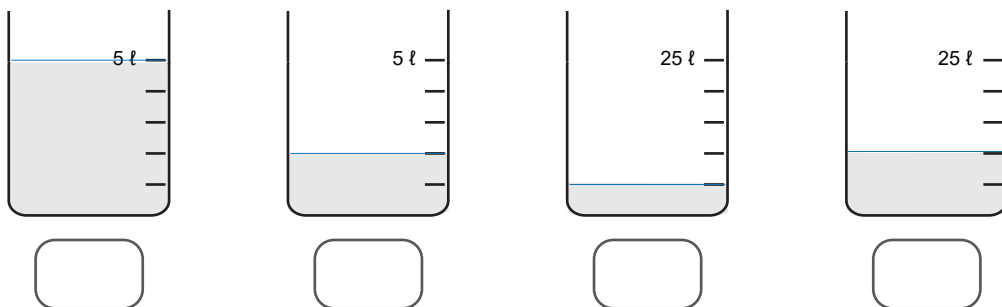

Check (✓) the beakers with a volume of 10 liters

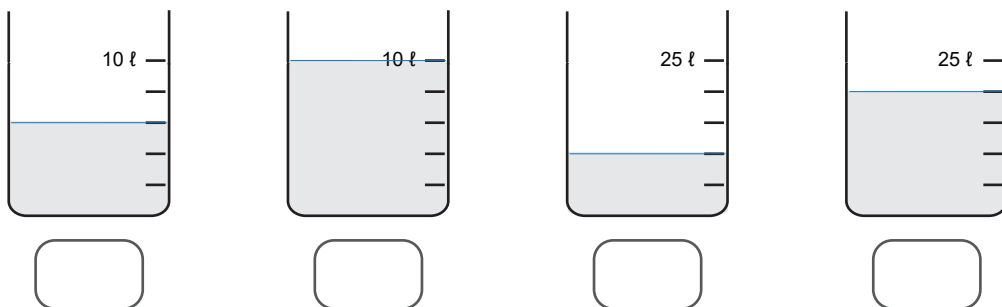

## Measure the volume of beakers

Check (✓) the beakers with a volume of 4 liters

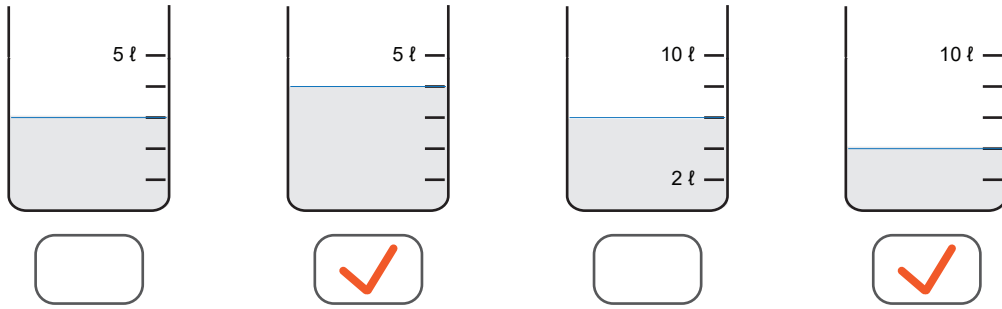

Check (✓) the beakers with a volume of 6 liters

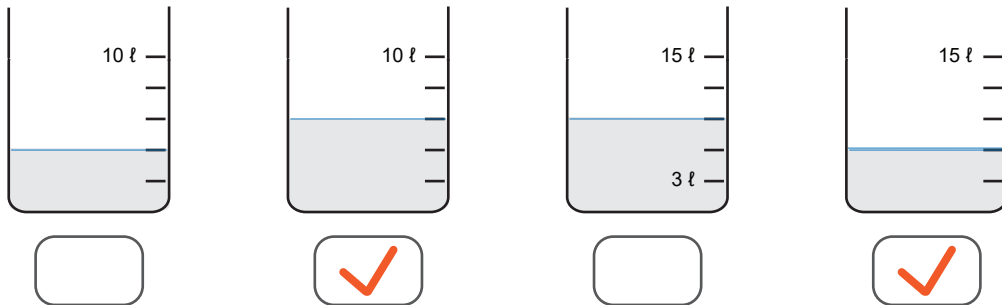

Check (✓) the beakers with a volume of 5 liters

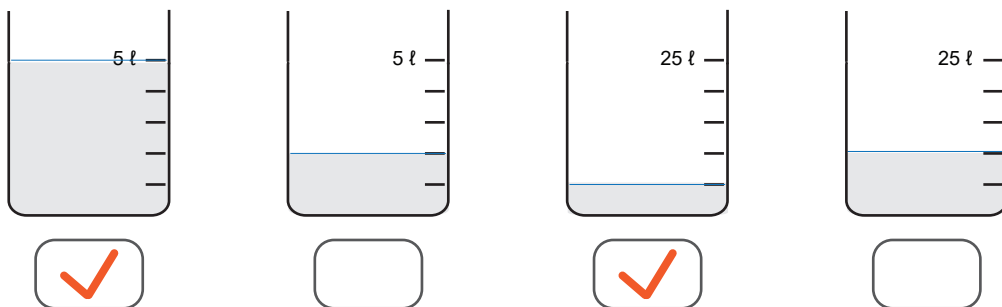

Check (✓) the beakers with a volume of 10 liters

