

Draw the Pointer

Name: _____ Class: _____

Draw the pointer on each of the following weighing scales.

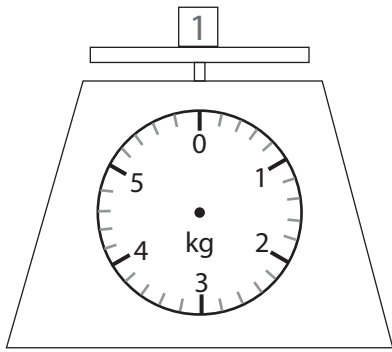

1 kilogram

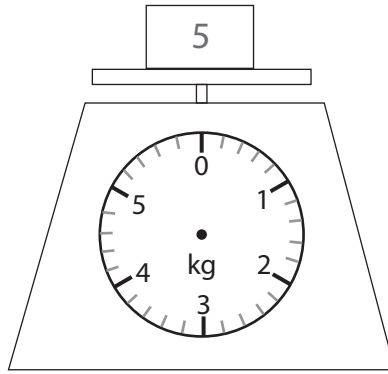

5 kilograms

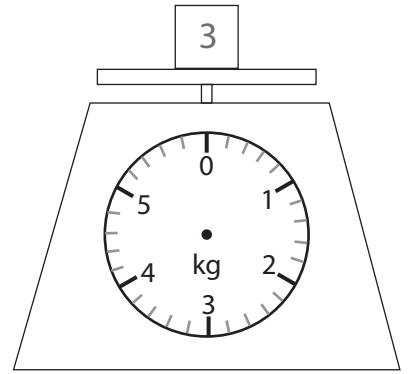

3 kilograms

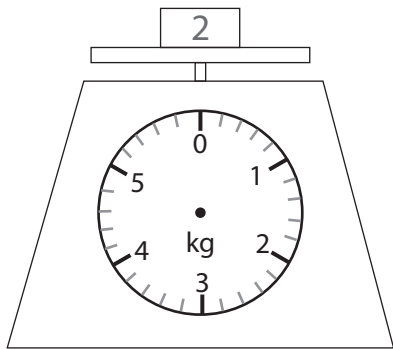

2 kilograms

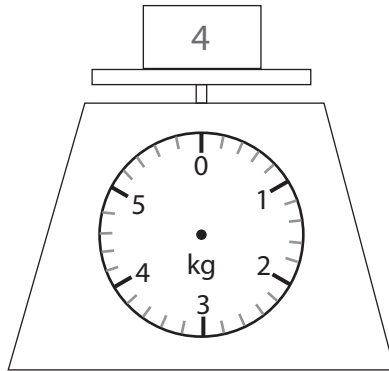

4 kilograms

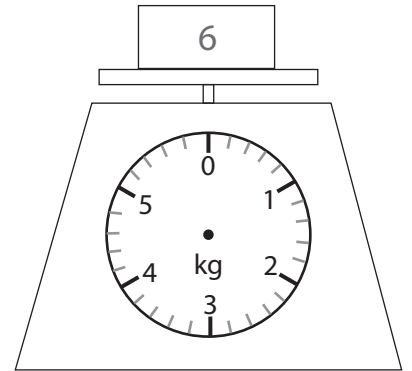

6 kilograms

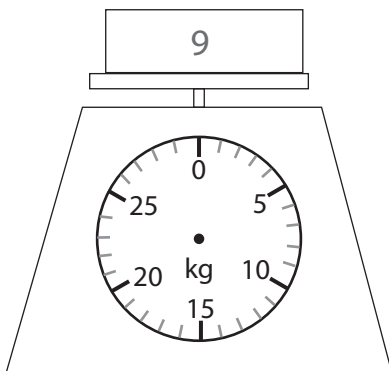

9 kilograms

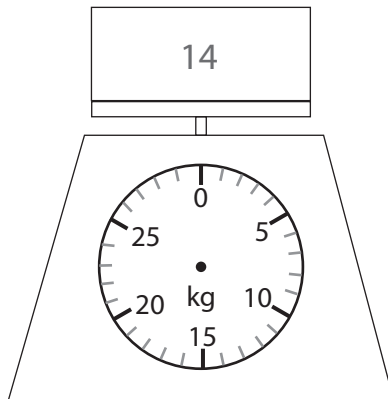

14 kilograms

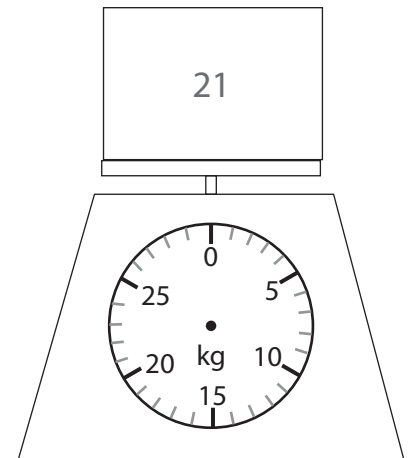

21 kilograms

Answers

Draw the pointer on each of the following weighing scales.

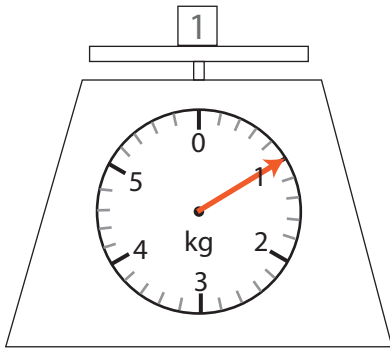

1 kilogram

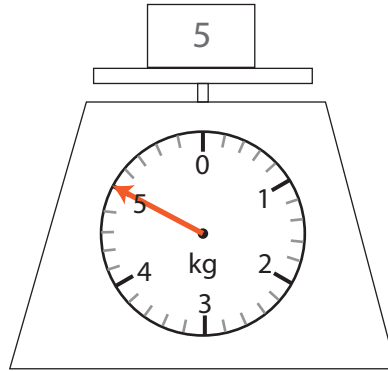

5 kilograms

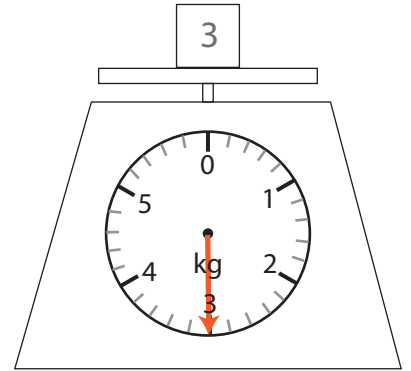

3 kilograms

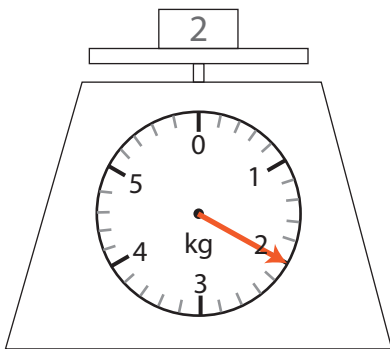

2 kilograms

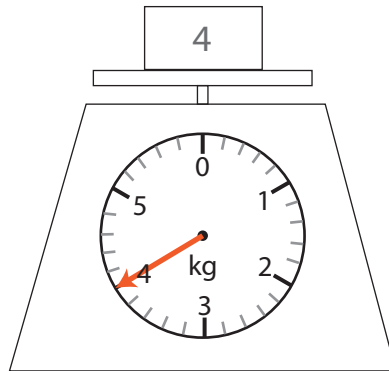

4 kilograms

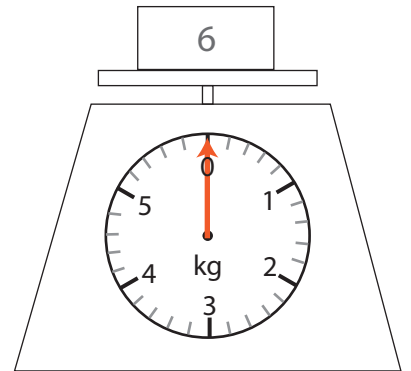

6 kilograms

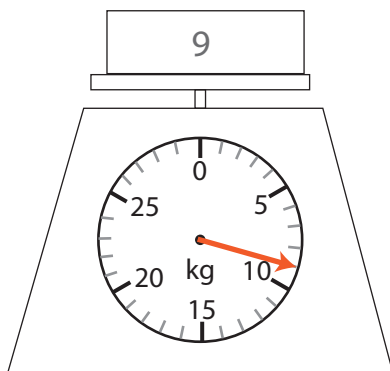

9 kilograms

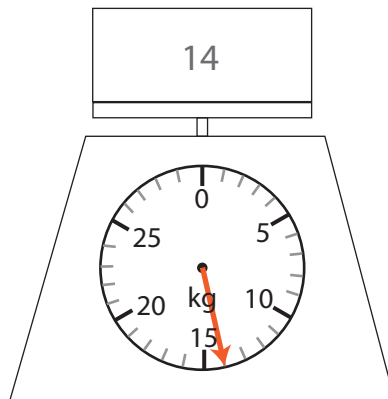

14 kilograms

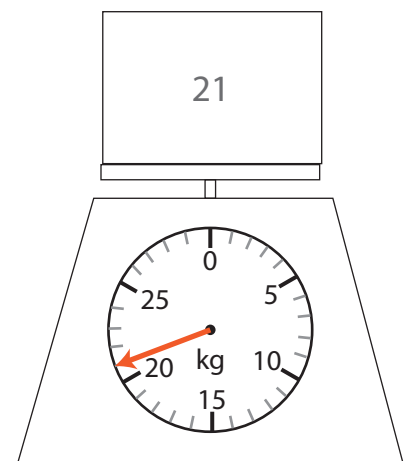

21 kilograms