

# Drawing Circles

Name: \_\_\_\_\_ Class: \_\_\_\_\_

Use the grids to draw circles given the radiuses. Use your compass and start in the center of the grids

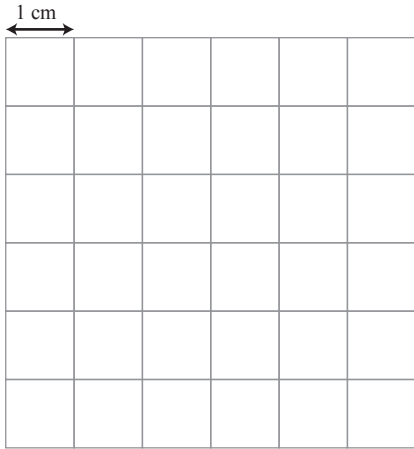

Radius: 3 cm

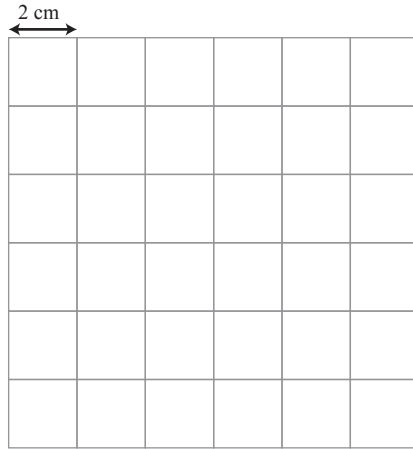

Radius: 2 cm

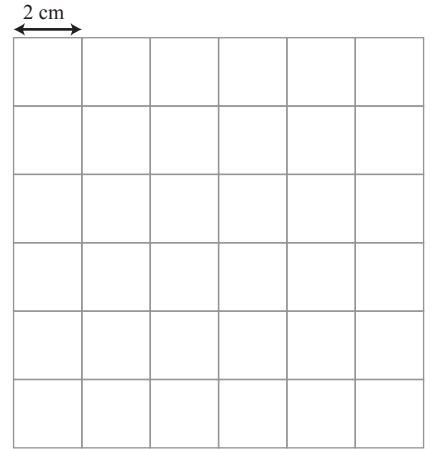

Radius: 4 cm

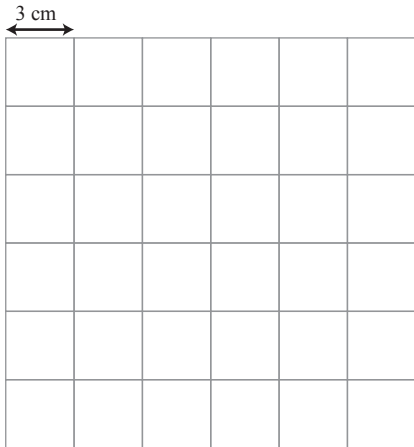

Radius: 9 cm

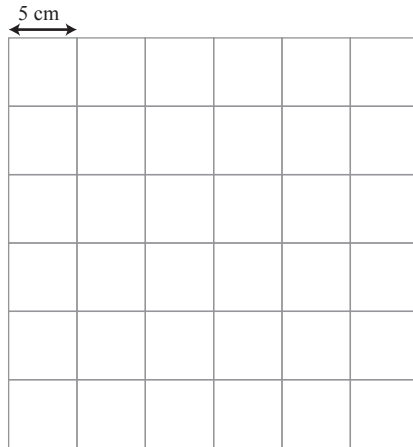

Radius: 10 cm

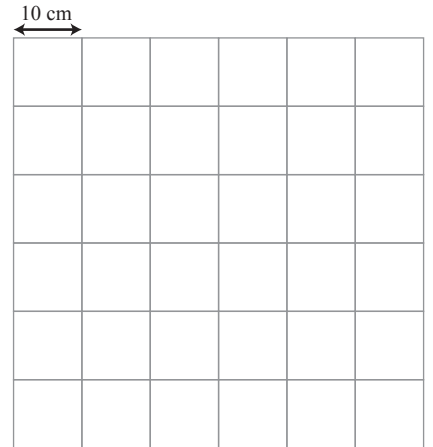

Radius: 5 cm

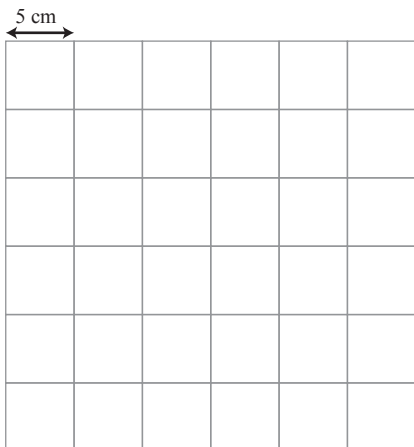

Radius: 15 cm

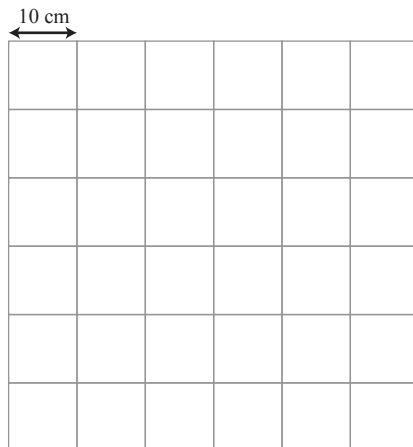

Radius: 20 cm

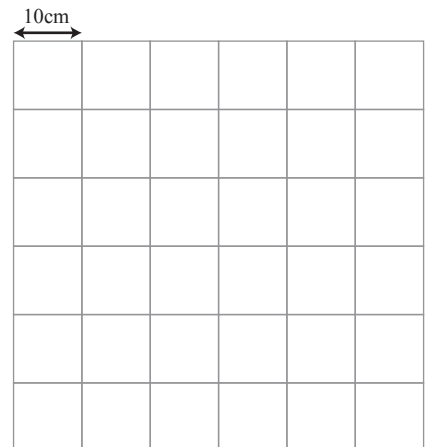

Radius: 30 cm

# Answers

Use the grids to draw circles given the radiuses. Use your compass and start in the center of the grids

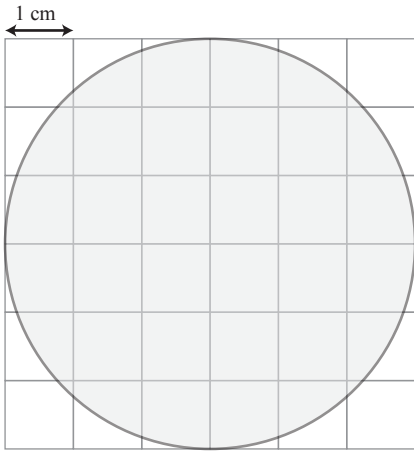

Radius: 3 cm

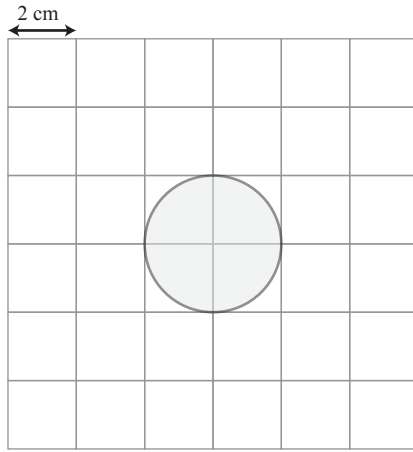

Radius: 2 cm

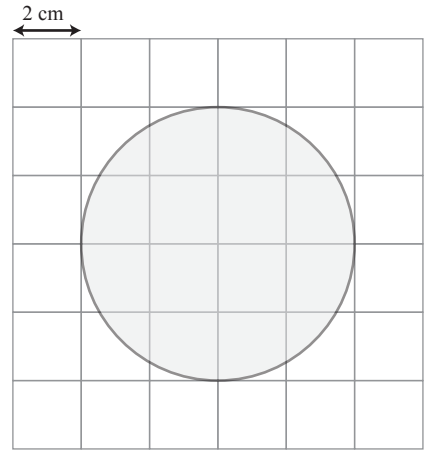

Radius: 4 cm

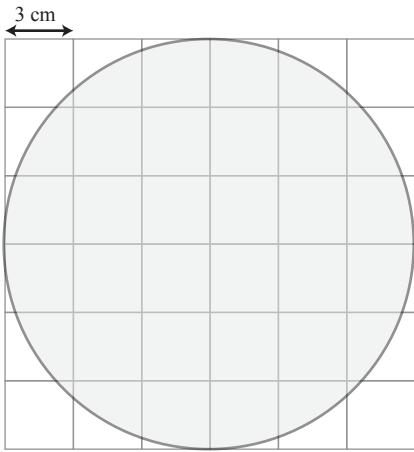

Radius: 9 cm

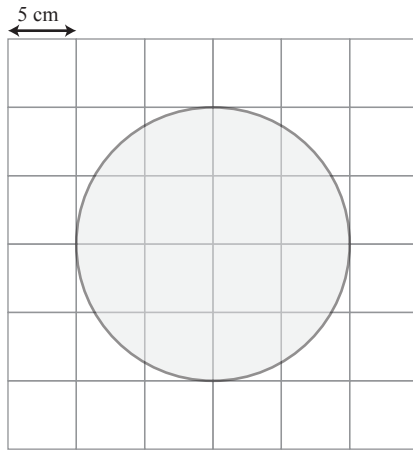

Radius: 10 cm

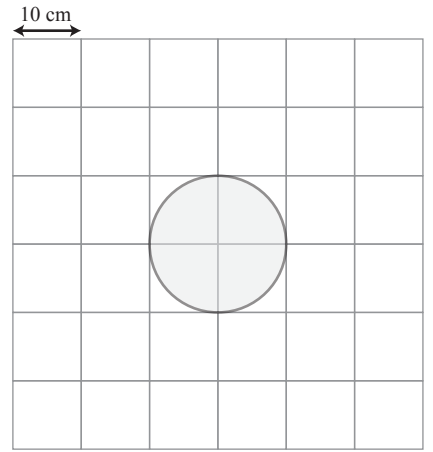

Radius: 5 cm

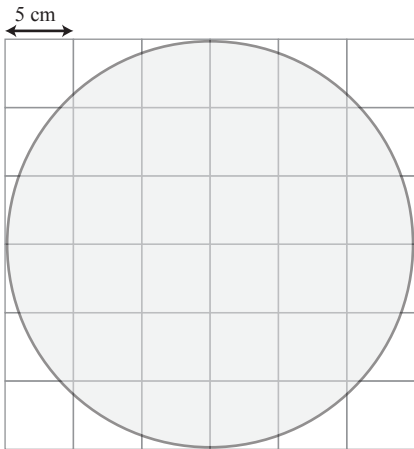

Radius: 15 cm

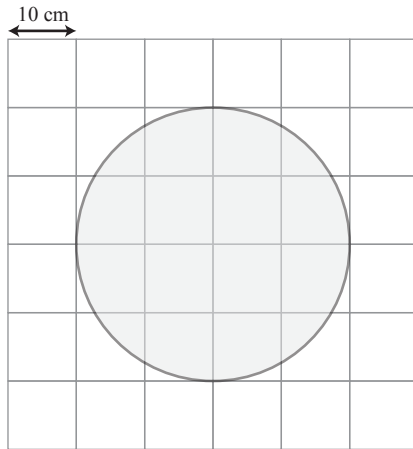

Radius: 20 cm

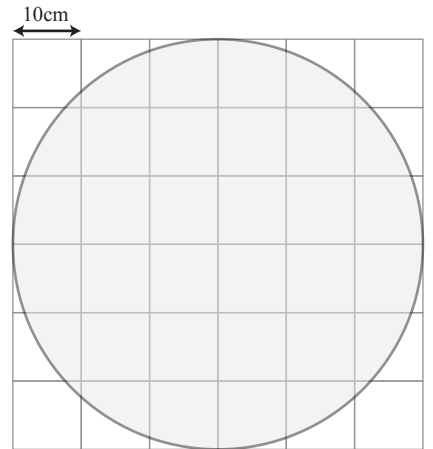

Radius: 30 cm